

PR57

AC "POWERITE"®

Variable Isolation Transformer & Safety Analyzer

Operation, Application, and Maintenance Manual

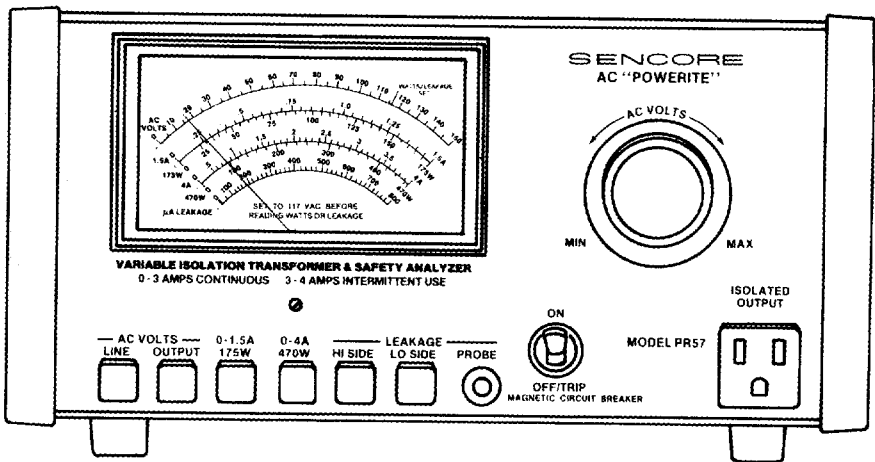

SENCORE

3200 Sencore Drive, Sioux Falls, South Dakota 57107

WARNING

Please Observe These Safety Precautions

There is always a danger present when testing electronic equipment. Unexpected high voltages can be present at unusual locations in defective equipment. Become familiar with the equipment you're working with and observe the following safety precautions.

Every precaution has been taken in the design of your instrument to insure that it is as safe as possible. However, safe operation depends on you, the operator.

1. **Never exceed the limits of this instrument** as given in the specification section and the additional special warnings in this manual.
2. **Never use the PR57 to isolate your test equipment**, only use it to isolate the equipment that you are servicing.
3. **Never plug more than one unit at a time into the PR57.** To do so could defeat the isolation transformer and present a possible shock hazard to the technician.
4. **Remove the circuit power before making connections to high voltage points.**
5. **Discharge filter capacitors** before connecting test leads to them.
6. **Be sure your equipment is in good order.** Broken or frayed test leads can be extremely dangerous and can expose you to dangerous voltages.
7. **Remove the test leads immediately** after the test has been completed to reduce the possibility of shock.
8. **Do not work alone** when working on hazardous circuits. Always have another person close by in case of an accident. Remember, even a minor shock can be the cause of a more serious accident, such as falling against the equipment, or coming in contact with high voltages.
9. **Improper Fuse(s) Void Warranty.** Fuses are for your protection, so always replace fuse with proper type and current rating. The proper fuse type description is marked near the fuse holder and in the instruction manual. Always:
 - a. **Have the proper size replacement fuse in stock.** With each new instrument, be sure to update your fuse inventory with any special value fuses your instrument may require.
 - b. **Avoid situations that will blow the fuse.** When a protection fuse blows, note what caused the fuse failure. Prevent future fuse failures by following proper measuring procedures.

PR57

AC "POWERITE"®

Variable Isolation Transformer & Safety Analyzer

Operation, Application, and Maintenance Manual

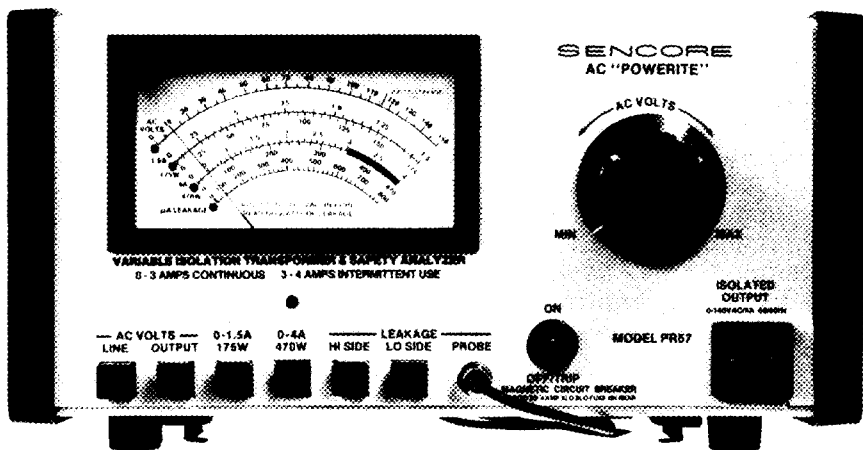

SENCORE

... the electronic instrument "analyzer people"

3200 SENCORE DRIVE, SIOUX FALLS, SOUTH DAKOTA 57107 • (605) 339-0100

TABLE OF CONTENTS

SAFETY PRECAUTIONS Inside Front Cover

SIMPLIFIED OPERATION

To Read Voltage of AC Line or Isolated Output	4
To Read Wattage or Current	4
To Read Leakage.....	5

DESCRIPTION

Introduction	6
Features	6
Specifications	7
Supplied Accessories	8
Controls.....	10

OPERATION

Introduction	12
Power Connection	12
Magnetic Circuit Breaker/Power Switch Operation	12
Fuse Replacement	13
Leakage Test Probe Mounting Clip	13
Using the Variable Voltage Output Function	14
Using the AC Line Monitor Position	14
Using the PR57 Current Function	15
Using the PR57 Watts Function	15
Determining the Wattage Rating of a Unit.....	16
Performing the Leakage Test	16
Determining the Allowable Leakage Level	18
Testing Leakage on Three-Wire Units.....	18
Checking the Calibration of the Leakage Test.....	19

APPLICATIONS

Troubleshooting Power Supplies.....	20
Troubleshooting Constant Voltage Transformer Power Supplies..	20
Checking Circuit Repairs at reduced Input AC Voltages	21
Reforming Power Supply Electrolytic Filters	21
Checking the Wiring of the AC Line Cord and Power Switch....	22
Testing Transformer Operated Devices for AC Leakage.....	23
Reading AC Leakage Levels Below 100 Microamps.....	23

MAINTENANCE

Disassembly Instructions	24
PR57 Calibration Procedure	24

SERVICE AND WARRANTY..... Inside Back Cover

NOTES

SIMPLIFIED OPERATION

TO READ VOLTAGE OF AC LINE OR ISOLATED OUTPUT

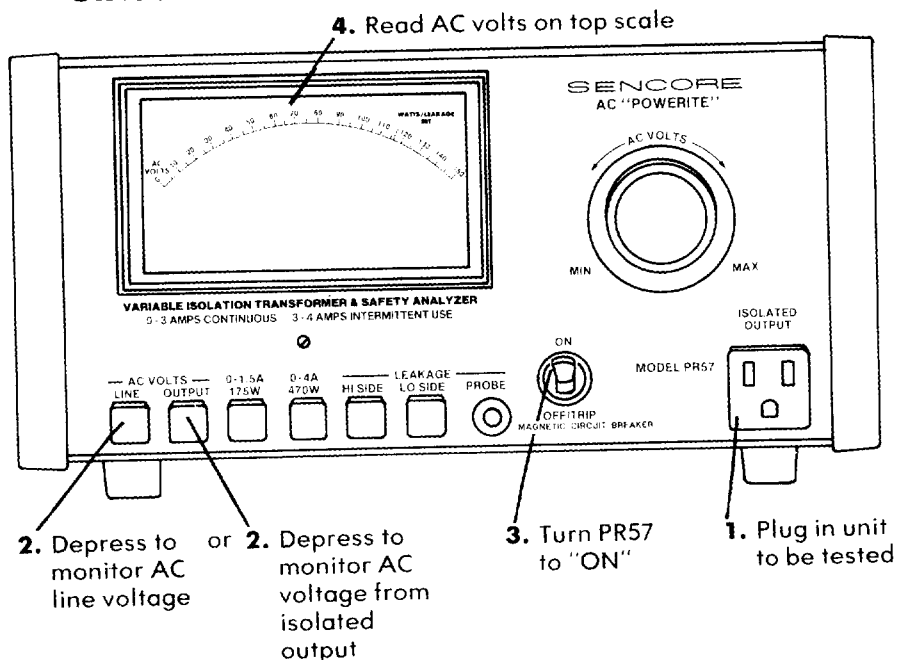

TO READ WATTAGE OR CURRENT

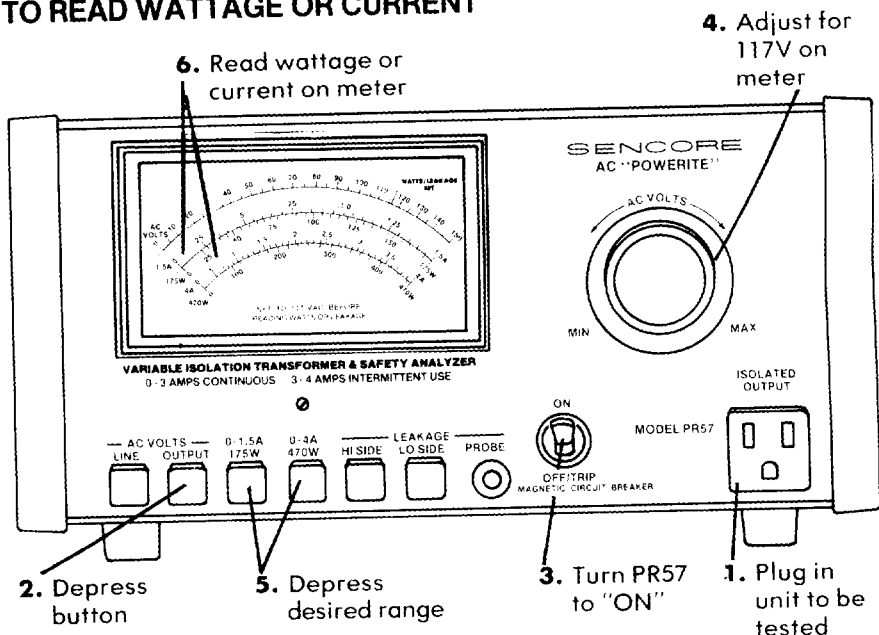

TO READ LEAKAGE

- 8. and 11. Read leakage in microamps on bottom scale
- 5. Adjust for 117 VAC on meter
- 1. Plug in unit to be tested

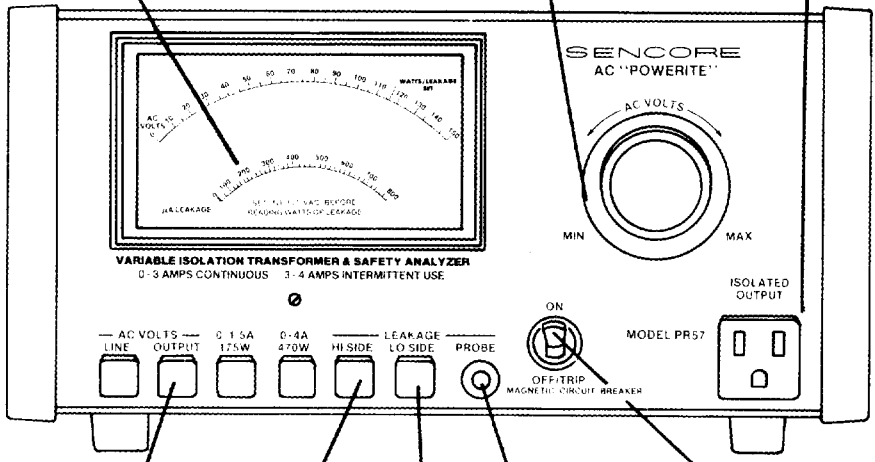

- 3. Depress button
- 6. Depress
- 9. Depress
- 2. Connect leakage probe
- 4. Turn on



- 12. Depress if any leakage shows on meter
- 7. and 10. Make contact with exposed metal parts

DESCRIPTION

INTRODUCTION

Many electronic devices that operate from the AC line do not have an isolation transformer. Some of these chassis have one side of the AC line connected directly to the chassis. Other devices use a full-wave bridge rectifier connected to the chassis which places the chassis at one-half the line voltage no matter how the line cord is connected to the AC line. These chassis must be isolated from the common side of the AC line with an isolation transformer to prevent shock hazards and to prevent the possibility of damaging the device under test or test equipment connected directly to the chassis.

Many new circuit troubleshooting procedures require that the AC line voltage be adjustable to test regulators, shut-down circuits, and other voltage sensitive circuits. Increasing or reducing the line voltage can also help locate intermittent problems that do not show up with 117 volts applied to the input.

The ability to monitor the current or power drawn from the AC line often simplifies troubleshooting of power supply or power output stage problems. Abnormally high power consumption indicates a problem that may not be immediately recognized but which may cause problems in the future.

Finally, every unit serviced should be checked to make sure that exposed metal parts do not pose a shock hazard to the user. A safety test is recommended by all manufacturers. This test is often not done because the procedures given in service literature are difficult to perform and interpret.

The PR57 AC POWERITE™ is an AC safety supply designed to make sure that every factor related to power is correct. The operation is simplified and all of the features needed to meet these needs are included in a single, compact instrument.

FEATURES

The Sencore PR57 POWERITE™ features four functions in one compact package. First, the PR57 has an isolation transformer to isolate chassis that have one side connected directly to the AC power line to eliminate shock hazards during service. The isolation transformer also provides safety for the test equipment and prevents possible damage to the set itself.

Second, the PR57 has a variable AC transformer that allows you to vary the isolated AC output voltage from 0 to 140 volts AC. You can apply a high and low line to check regulator and shut down circuit operation or apply a high line to cook out that intermittent trouble.

Third, the PR57 meter lets you monitor the AC line voltage or the AC voltage from the isolated output. The meter also allows you to monitor the wattage and current being drawn by the unit under test. The PR57 meter lets you know when the voltage and power are right.

Fourth, the PR57 provides a safety leakage test so you can check each customer's set for AC line leakage as recommended by most manufacturers. There is no external resistors or meters to hook up with the PR57. Simply depress a button, touch the exposed metal parts with the Safety Leakage Test Probe and read the leakage current on the meter.

The PR57 POWERITE™ also features a magnetic circuit breaker backed up by a 4 Amp slo-blo fuse. The PR57 is protected, even from a direct short on the isolated output. The PR57 also has only one isolated output to prevent plugging in more than one unit and defeating the isolation of the isolation transformer and creating a potential shock hazard.

SPECIFICATIONS

ISOLATED OUTPUT:

VOLTAGE: 0-140 VAC (typical) continuously variable.

CURRENT: 0-3 Amps continuous; 3-4 Amps intermittent usage (five minutes on, five minutes off).

AC LINE LEAKAGE: 50 uA max., either isolated output to ground.

AC LINE MONITOR:

LINE VOLTAGE: 0-150 VAC $\pm 3\%$ F.S. (calibrated at 117 VAC).

OUTPUT VOLTAGE: 0-150 VAC, $\pm 3\%$ F.S. (calibrated at 117 VAC).

OUTPUT CURRENT: Ranges: 0-1.5, 0-4 Amps AC; Accuracy at any output voltage: 3% F.S.

OUTPUT WATTAGE: Ranges: 0-175, 0-470 watts; Method: volts times amps product; Accuracy: 3% F.S. with output voltage set to 117 VAC.

SAFETY LEAKAGE TEST (Patent Pending):

RANGE: 0-800 uA, $\pm 3\%$ F.S. (calibrated at 500 uA).

METHOD: Referenced to either side of isolated output jack (switch selected).

PROTECTION:

AC INPUT: 4 Amp magnetic circuit breaker built into power switch.

ISOLATED OUTPUT: 4 Amp type 3AG slo-blo fuse on back panel.

GENERAL:

METER: 4½", moving coil, 1900 ohm, 100 uA F.S., diode protected against overload; Accuracy: ± 2%.

INPUT POWER: 105-125 VAC, .4 Amps idle current with no output load with 117 VAC input.

SIZE: 6" x 11½" x 12¾" (15.2 x 29.2 x 32.4 cm.) HWD.

WEIGHT: 18 lbs. (8.2 Kg.)

ACCESSORIES (Supplied):

39G148 Safety Leakage Probe with built-in calibration check.

64G35 Leakage Probe Mounting Clip

44G23 Spare 4 Amp type 3AG slo-blo fuse.

NOTES

CONTROLS

1. **AC VOLTS LINE pushbutton:** Depress to monitor the AC line input voltage on the meter (11) using the AC VOLTS scale (11A).
2. **AC VOLTS OUTPUT pushbutton:** Depress to monitor the AC voltage at the ISOLATED OUTPUT (9). Read the value of voltage on the meter (11) using the AC VOLTS scale (11A).
3. **0-1.5A/175W pushbutton:** Depress to read current under 1.5 amps or power less than 175 watts. Read value on meter (11) using 0-1.5A/175W scale (11B).
4. **0-4A/470W pushbutton:** Depress to read current to 4 amps or power to 470 watts. Read value on meter (11) using scale 0-4A/470W (11C).
5. **HI SIDE LEAKAGE pushbutton:** Depress to read AC leakage referenced to the high (hot) side of the AC line at ISOLATED OUTPUT jack (9). Use with SAFETY LEAKAGE PROBE (12) connected to PROBE JACK (7). Read leakage in microamps on meter (11) using μ A LEAKAGE scale (11d).
6. **LO SIDE LEAKAGE pushbutton:** Depress to read AC leakage referenced to the low (common) side of the AC line at ISOLATED OUTPUT jack (9). Use with SAFETY LEAKAGE PROBE (12) connected to PROBE jack (7). Read leakage in microamps on meter (11) using μ A LEAKAGE scale (11d).
7. **LEAKAGE PROBE input jack:** Insert leakage probe (12) before making leakage tests using LEAKAGE buttons (5 or 6).
8. **ON-OFF/TRIP switch:** Combination on-off switch and magnetic circuit breaker to protect PR57 against overloads.
9. **ISOLATED OUTPUT socket:** For isolated and variable AC voltage for unit to be tested.
10. **AC VOLTS control:** Adjusts the isolated AC output voltage from 0-140 volts AC at the ISOLATED OUTPUT socket (9). Read variable voltage on meter (11) by depressing OUTPUT VOLTAGE pushbutton (2) using the AC VOLTS scale (11A).
11. **Meter:** Provides the four scales for voltage, current, power, and leakage for the PR57 tests.
- 11A. **AC VOLTS scale:** Indicated by LED when either AC VOLTS LINE (1) or AC VOLTS OUTPUT (2) pushbutton is depressed.

- 11B. 0-1.5A/175W scale: Indicated by LED when 0-1.5A/175W push-button (3) is depressed.
- 11C. 0-4A/470W scale: Indicated by LED when 0-4A/470W push-button (4) is depressed.
- 11D. Leakage scale: Indicated by LED when either HI SIDE (5) or LO SIDE LEAKAGE pushbutton (6) is depressed.
12. Safety Leakage Probe: Used to make all safety leakage tests on sets before returning them to the customer.
13. Leakage Test Switch: Depressed after a leakage reading is obtained on meter (11) to indicate the true leakage in microamps on the leakage scale (11D) on the meter. When button is not pressed, internal resistor prevents meter from pegging on high leakages and provides means of testing calibration of leakage test circuit.

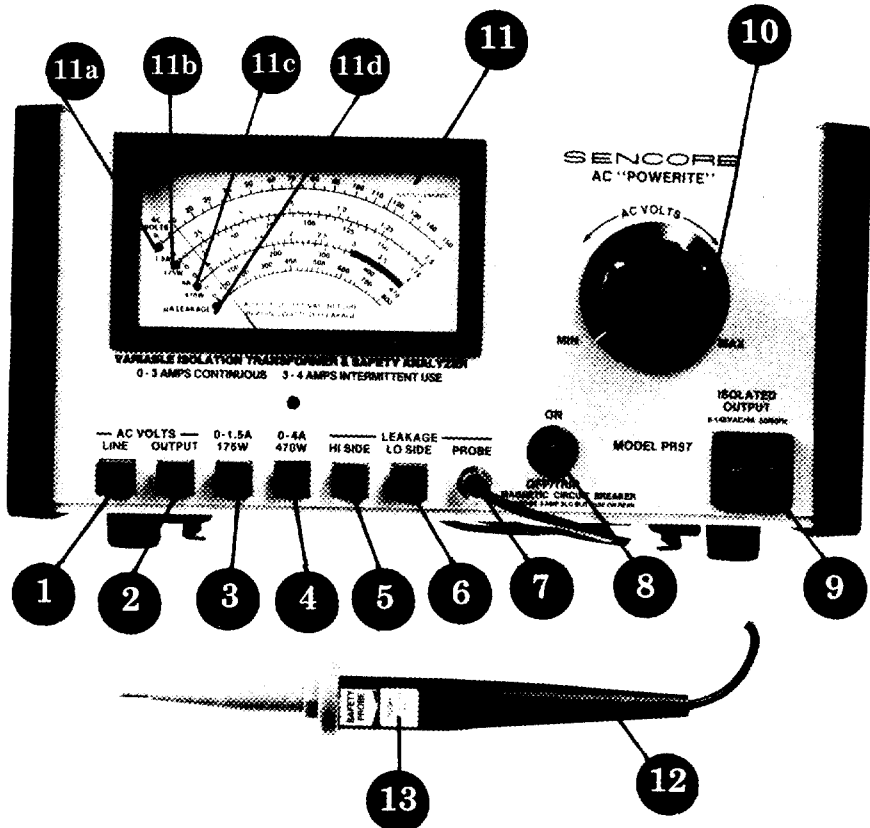

Fig. 1 — Location of controls and features of the PR57.

OPERATION

INTRODUCTION

Before operating your PR57 for the first time, take a few minutes to read through the operations and applications sections of the manual. Acquaint yourself with the features and tests that can be performed with the PR57. The PR57 is not only an isolation transformer, it is a troubleshooting tool that will aid you in the daily service as well as provide protection against shock hazards.

POWER CONNECTION

The PR57 is designed to operate from a 105 to 125 VAC, 60 Hertz power line. The PR57 should be plugged into a properly grounded three wire outlet for maximum safety.

MAGNETIC CIRCUIT BREAKER/ POWER SWITCH OPERATION

WARNING

The magnetic circuit breaker is for your safety and protection of the PR57. Do not defeat its operation.

The PR57 is protected from overload by a magnetic circuit breaker built into the power on-off switch. The breaker interrupts the AC power applied to the PR57 when tripped by an overload or set to the OFF/TRIP position by hand. The circuit breaker portion is reset after an overload by returning the switch handle to the ON position.

It is normal for the circuit breaker to allow the PR57 to operate for several seconds above the 4 amp rating. The circuit breaker will trip instantly if a short circuit is applied to the ISOLATED OUTPUT. The time delay during an overload less than a dead short will not cause damage to the PR57 circuits.

SPECIAL NOTES:

1. After an overload, allow the circuit breaker to sit for a few seconds before resetting to allow the magnetic elements inside the breaker to stabilize. Attempting to reset the breaker immediately after it has tripped may result in the breaker returning to the "tripped" mode.
2. The breaker may occasionally trip when turned to the ON position even though there is no overload. This is normally caused by the

switch contacts closing at the peak of the AC line voltage. Simply repeat the turn-on process until the breaker remains on.

3. If the breaker will not remain in the ON position after several attempts, the load connected to the ISOLATED OUTPUT may have a short circuit. Disconnect the load, then turn the MAGNETIC CIRCUIT BREAKER/POWER switch on again. If the breaker continues to trip, the PR57 may have an internal short. Refer to the "Maintenance and Service" section of this manual for details.

FUSE REPLACEMENT

WARNING

Always replace the fuse on the rear panel of the PR57 with a 3AG, 4 Amp slo-blo type fuse, Sencore part number 44G23, or its exact equivalent. Any other rating or size fuse may cause internal damage to the PR57 and will void all warranties.

The PR57 uses an additional back-up fuse to protect the variable AC transformer from damage with excessive current drawn at low output voltages. A 3AG, 4 Amp slo-blo fuse, mounted on the rear panel, is in series with the isolated output. If the output voltage read on the PR57 meter drops to 0, and the magnetic breaker has not tripped, check the 4 Amp fuse on the rear panel. If the fuse continues to blow with a unit connected to the PR57, check the unit for a malfunction in the AC input or power supply circuits.

LEAKAGE TEST PROBE MOUNTING CLIP

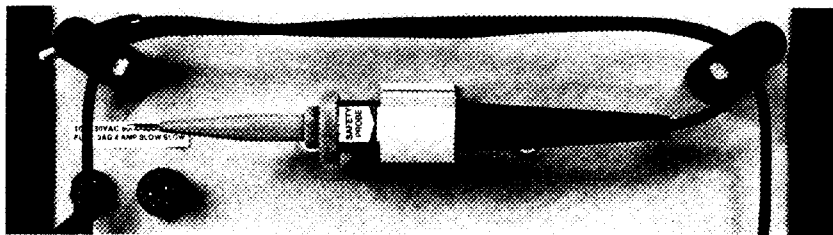

Fig. 2 — The Safety Leakage Probe may be stored on the rear of the PR57 with the special mounting clip supplied. This keeps the probe handy when needed to make the Safety Leakage Test.

A special mounting clip (64G35) is included with the spare parts for the PR57. This special clip may be mounted on any clean, dry surface to hold the Safety Leakage Probe. Simply peel off the paper backing on the clip, place it at the location to be mounted, and press firmly. Mounting the clip on the rear of the PR57 allows the probe to be stored out of the way and still be available for use when the PR57 is carried to the job. The clip may also be mounted directly to a work bench or other surface next to the PR57. Additional clips may be ordered from the Sencore Service Department, 3200 Sencore Dr., Sioux Falls, SD 57107.

USING THE VARIABLE VOLTAGE OUTPUT FUNCTION

The PR57 POWERITE™ variable voltage output is 0 to 140 volts AC RMS. This can be very handy for troubleshooting power supply problems, start up circuits and checking circuit repairs before applying full voltage to them. The top meter scale reads out in AC volts RMS so that you know just how much voltage is at the ISOLATED OUTPUT.

WARNING

Never connect more than one unit at a time to the ISOLATED OUTPUT. If more than one unit is connected to the output of the PR57, it may defeat the isolation between the units and may create a shock hazard between units.

To use the Variable Output Voltage function of the PR57:

1. Plug the PR57 into a properly grounded three wire AC outlet.
2. Turn the PR57 ON and depress the AC VOLTS OUTPUT pushbutton. The LED on the left side of the AC volts meter scale should come on.
3. Adjust the AC VOLTS knob for the desired output voltage as indicated on the meter.

NOTE: Adjusting the AC VOLTS control will change the AC output voltage regardless of which pushbutton is depressed.

USING THE AC VOLTS LINE MONITOR POSITION

The PR57 can be used to monitor the AC line voltage coming into your shop or work bench. To monitor the AC line voltage:

1. Plug the PR57 into a properly grounded three wire AC outlet.
2. Depress the AC VOLTS LINE pushbutton.
3. Turn the PR57 to ON with the ON-OFF/TRIP switch.

The meter will now read the AC line voltage being applied to the input of the PR57. The PR57 may be left in this mode anytime that it is not being used to measure current, isolate a set or make leakage tests to act as an AC line monitor.

USING THE PR57 CURRENT FUNCTION

The PR57 has two current ranges, 0-1.5 Amps and 0-4 Amps. Each range has its own pushbutton and meter scale. The PR57 will deliver up to 3 Amps continuously and 3 to 4 Amps intermittent duty (5 minutes on, 5 minutes off). The current range calibration is independent of the setting of the AC VOLTS control. The meter is in series with the ISOLATED OUTPUT and measures the actual current drawn by the unit under test regardless of the voltage being applied. The AC VOLTS control only needs to be set to the 117 volt set point if the current readings are being compared to the full rated current consumption of the device under test.

To use the current function:

1. Plug the PR57 into a properly grounded three wire outlet.
2. Turn the PR57 ON-OFF/TRIP switch to the ON position.
3. Depress the AC VOLTS OUTPUT pushbutton and adjust the AC VOLTS control for the desired level of AC output. This would be 117 volts for comparing manufacturer's specifications or a lower voltage while troubleshooting a defective circuit.
4. Plug the unit to be tested into the ISOLATED OUTPUT and turn the unit on. Depress the 0-4A/470W pushbutton. If the meter reads less than 1.5 Amps, depress the 0-1.5A/175W pushbutton and read the actual current on the meter scale indicated by the LED.

USING THE PR57 WATTS FUNCTION

The PR57 has two wattage ranges, 0-175 and 0-470 watts. Each range has its own pushbutton and meter scale. The PR57 will deliver up to 350 watts continuously and 350 to 470 watts intermittent duty (5 minutes on, 5 minutes off). The wattage scales are calibrated at 117 volts AC RMS at the isolated outlet.

NOTE: The PR57 measures the volts times amps product and does not take the power factor of the circuit into consideration. There may be a slight difference between the true wattage and the wattage shown on the PR57 meter due to the inductive or capacitive nature of some power supplies. This slight difference can be ignored in service work.

To operate the PR57 for measuring watts:

1. Plug the PR57 into a properly grounded three wire AC outlet.
2. Turn the PR57 ON-OFF/TRIP switch to the ON position.

3. Depress the AC VOLTS OUTPUT pushbutton and adjust the AC VOLTS control for a reading of 117 volts (WATTS OR LEAKAGE SET line on meter) at the isolated output. The LED will light up indicating the AC VOLTS scale when the AC VOLTS pushbutton is depressed.

4. Plug the unit to be tested into the isolated output on the PR57 and turn the unit ON. Readjust the AC VOLTS control if necessary to bring the meter back to the 117 volt set point on the meter.

5. Depress the 0-4A/470W pushbutton and note the reading on the meter scale indicated by the LED. If the reading is below 175 watts, depress the 0-1.5A/175W pushbutton and read the power on the meter scale indicated by the LED.

DETERMINING THE WATTAGE RATING OF A UNIT

Most manufacturers will list the wattage or current drawn by the electronic device on a panel or a plate near the AC line cord input. This figure can be in either amps or watts. If the figure is in amps, read the top figures of the scale and if in watts, read the bottom figures. These figures will generally be the highest allowable levels unless otherwise listed.

Some manufacturers are now listing the power as a typical power figure. This is derived by finding the maximum current and the minimum current and calculating an average figure. The unit should be checked at a normal viewing level for a TV or at the recommended output for an audio system.

If no figure is listed, check the circuit breaker or fuse rating. The average current drawn will be about $\frac{2}{3}$ the level of the fuse or circuit breaker. This is only a guide and not an exact figure. Different manufacturers may vary from this typical overrating of a fuse or breaker. A good idea is to record typical figures from properly operating sets on the schematic so you have a reference to use when servicing future chassis of the same type.

PERFORMING THE LEAKAGE TEST



Fig. 3 — The pushbutton on the Safety Leakage Probe is depressed when the actual value of leakage current is to be read on the meter.

The leakage test is performed to determine if there is any AC line voltage leakage on any exposed metal part of the device under test. Any leakage indicates a potential shock hazard to anyone touching the exposed part that has leakage. This test is found on the safety page of most manufacturer's service literature and recommended by all. The test should be performed on a completed unit that is in the cabinet and ready to return to the customer. The PR57 simplifies this leakage test with the built-in leakage circuit and special Safety Leakage Probe. Simply touch the probe to all exposed metal parts and read the leakage on the meter.

SPECIAL NOTE:

The Leakage test must be made with no connections to the chassis except the Safety Leakage Probe. If any piece of test equipment (other than the PR57) or an antenna is connected to the chassis, the leakage readings may be inaccurate.

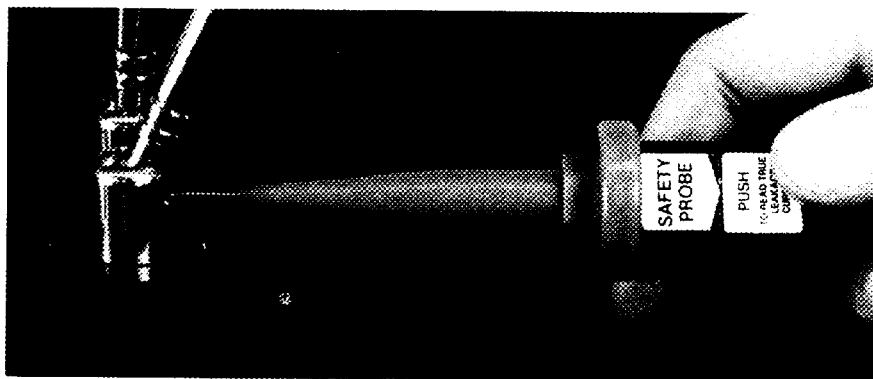

Fig. 4 — The Safety Leakage Test should be made to all exposed metal parts such as the antennas shown here.

To perform the Leakage Test:

1. Plug the PR57 into a properly grounded three wire AC outlet.
2. Depress the AC VOLTS OUTPUT pushbutton and adjust the AC VOLTS control for a reading of 117 volts on the PR57 meter.
3. Plug the unit to be tested into the ISOLATED OUTPUT on the PR57 and turn it on. Readjust the AC VOLTS control, if necessary, to read 117 volts on the meter.
4. Depress the HI SIDE LEAKAGE pushbutton and plug the Safety Leakage Probe into the PROBE jack on the front panel.
5. Touch the probe tip to every piece of exposed metal, including screw heads, antennas, antenna terminals, knobs, all control shafts, with the knobs removed, handles or anything that even appears to be metallic.

6. Depress the LO SIDE LEAKAGE pushbutton and repeat the leakage test to the same points tested in step 5.

The Safety Leakage Probe has a switch which places a current-limiting resistor in series with the current test circuit. The resistor is bypassed when the button on the probe is depressed and in series when the probe switch is in the normal "out" position.

This resistor limits the amount of current to prevent the meter from pegging when a test point with high leakage is contacted. This condition occurs when the point being tested is connected directly to either side of the AC line. The meter is protected against damage, even without the limiting resistor in the circuit, but the limiting resistor offers additional protection.

Any test point that reads full scale (800 μ A) with the button in the "out" position is connected directly to the side of the AC line indicated by the LEAKAGE pushbutton used for that portion of the safety test. If, for example, the meter reads full scale when the LO SIDE button is depressed, there is a direct connection to the common side of the AC line. This is the side of the polarized line cord plug with the larger connector.

Leakage readings, less than full scale, indicate that there is a leakage path (but not a dead short) to the point being tested. Simply press the button on the Safety Leakage Probe to read the actual leakage current present.

DETERMINING THE ALLOWABLE LEAKAGE LEVEL

The maximum allowable leakage level of an electronic device is printed in the manufacturer's service literature on the safety page. This is the maximum level of leakage that conforms with all standards to insure customer safety. The present level of leakage on consumer electronic devices is 500 microamps. Some manufacturers will publish a figure that is lower than the 500 microamp level as a safety margin. Check each set to the manufacturer's specified safe leakage level.

Sets manufactured prior to 1972 were designed to meet the 750 microamp leakage level. Be sure to check these sets at the level specified.

TESTING LEAKAGE ON THREE—WIRE UNITS

The PR57 leakage test is designed to operate exactly the same on a unit with a two-wire AC line cord or a 3-wire (grounded) AC line cord. The ground connector on the ISOLATED OUTPUT jack is connected to earth ground through the power cord of the PR57. This assures safe operation of the unit under test as its chassis is maintained at earth

potential. This ground path does not affect the safety leakage test. The leakage between the internal circuits and the chassis will be properly read by simply touching the Safety Leakage Probe to the chassis. Do not defeat the third-wire ground.

CHECKING THE CALIBRATION OF THE LEAKAGE TEST

The calibration of the PR57 leakage test can be tested at any time so that you will know that the readings obtained during the test are correct.

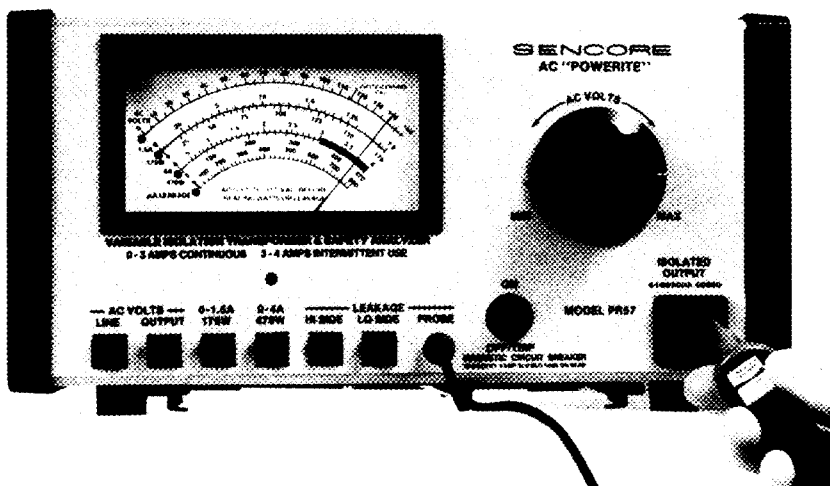

Fig. 5 — The built-in calibration resistor in the Safety Leakage Probe allows a quick check of the leakage scale calibration by inserting the Safety Leakage Probe into the Isolated Output and checking for a full scale leakage reading.

1. Plug the PR57 into a properly grounded three-wire AC outlet.
2. Depress the AC VOLTS OUTPUT and turn the PR57 ON. Adjust the AC VOLTS control for a reading of 117 volts on the PR57 meter.
3. Plug the leakage probe into the PROBE jack and depress the HI SIDE LEAKAGE pushbutton. Place the probe tip into the small blade opening of the ISOLATED OUTPUT socket on the PR57. The meter should read 780 microamps (full scale). If the reading is off, check the calibration of the PR57 using the procedure described in the Maintenance section of this manual.

NOTE: Be sure that the PR57 ISOLATED OUTPUT is set to 117 volts. The accuracy of this setting determines the accuracy of the leakage test.

APPLICATIONS

TROUBLESHOOTING POWER SUPPLIES

Many power supply troubles cause the circuit breaker to trip or fuse to blow on the unit under test when the full AC line voltage is applied to the input. This makes it difficult to locate the defect causing the excessive current flow. Many of these power supplies will operate without tripping the breaker or blowing the fuse if the input AC line voltage is reduced to about 60 volts. At this level of AC line voltage, the resultant unregulated DC voltages in the power supply will be about one-half the level normally found on the schematic.

The normal action of a power supply is to increase the current from the AC line as the AC line voltage is increased. At the 60 volt level, the current drain should be one-half or less that of the full applied AC line voltage condition. If the drain is excessive, it indicates a defect in the power supply or associated circuits. You may disconnect load circuits from the power supply one at a time to isolate the circuit that is drawing the excessive current.

If the power supply is used in tube-operated equipment, the output voltage from the supply with 60 volt AC line input will normally be greater than one-half. This is because the filaments of the tubes are not warm enough to allow the tubes to fully conduct. You may slowly increase the applied voltage in these cases until the tubes begin to conduct or the circuit breaker on the unit being tested trips. Then reduce the AC voltage from the PR57 until the set will operate without tripping the breaker. This will allow you to make measurements to locate the defect.

If the breaker will not trip until the tubes are warm enough to conduct, a tube may have a short or other internal problem causing the trouble.

TROUBLESHOOTING CONSTANT VOLTAGE TRANSFORMER POWER SUPPLIES

The constant voltage transformer uses a capacitor across a secondary winding that "tunes" the transformer. This capacitor is generally about a 2 to 5 microfarad oil-filled type. The secondary voltage of a constant voltage transformer remains constant over a wide range of input voltages. In many cases, the capacitor opens and the defect is not noticed unless a wide range of AC voltage is applied to the circuit.

The constant voltage transformer and capacitor can be checked and troubles located in the supply by lowering the applied AC voltage. The normal action of the "tuning" of the capacitor can readily be seen if the voltage is increased from about 60 volts to 90 volts AC while moni-

toring the AC current on the PR57. The current will increase to a level higher than the normal current at 117 volts as the transformer attempts to keep the output voltage at a constant level. When the input voltages reaches about 90 volts, the tuning will take effect and the current will start to decrease as the voltage is increased.

As the voltage is increased further to 117 volts, the current will decrease and dip at around 117 volts. If the voltage is increased further, the current will again begin to increase. If a constant voltage transformer circuit does not exhibit this change in current with change in voltage, either the capacitor is open or the tuning winding on the transformer is open.

NOTE: The secondary voltage waveform is a square wave in a properly operating constant voltage transformer. Use a scope or a DVM with a true RMS function to measure the voltage accurately.

CHECKING CIRCUIT REPAIRS AT REDUCED INPUT AC VOLTAGES

After repairs have been made to power supplies, horizontal output circuits or similar power type circuits, the unit should be tested at a reduced input voltage. This will reduce the possibility of damage if there is still another problem in the circuit. The lowered AC input voltage will allow the set to operate at reduced power and give you time to see if further repairs are necessary. A good place to start is at about 85 volts AC. Slowly increase the voltage while monitoring the current on the PR57 meter. If the current increases beyond the normal limits, turn the power to the PR57 OFF and recheck the circuit for a malfunction.

NOTE: In tube-operated equipment, allow time for the filaments to warm up as you increase the input voltage. If you adjust the input too fast, the tubes will not have a chance to warm up and the excessive current problem may not show up until it is too late. Allow about two seconds for each five volts that you increase the input voltage for the tubes to reach operating temperature.

REFORMING POWER SUPPLY ELECTROLYTIC FILTERS

The PR57 variable AC voltage can be used to reform the electrolytics on older sets that have been sitting for a long period of time. The electrolytic filters in the power supply could be leaky and should be operated at a lower input voltage first and then have the voltage increased slowly to the correct operating point. This will prevent gas build-up and possible damage to the capacitors. Simply plug the unit into the ISOLATED OUTPUT of the PR57. Set the AC VOLTS adjust to 60 volts, and allow the set to operate for 5 to 10 minutes.

Observe the current on the PR57 meter. It should decrease as the capacitors reform the insulating dielectric material. Increase the voltage in 5 volt steps and watch to see if the current decreases, indicating the capacitors are reforming after each voltage increase. If the current increases above the normal rating of the set and does not come down, a defect in the power supply or other circuits is indicated. The circuits may be further tested at reduced voltage to prevent additional circuit damage.

CHECKING THE WIRING OF THE AC LINE CORD AND POWER SWITCH

To meet all standards, a polarized line cord must be used on all chassis where one side of the AC line is connected directly to the chassis. The AC on-off switch on all sets must be wired to interrupt the hot side of the AC power line. Both conditions can be quickly checked with the PR57 leakage probe and HI and LO side leakage test.

To check the wiring of the AC line cord:

1. Plug the unit to be tested into the ISOLATED OUTPUT on the PR57 and turn both units ON.

2. Depress the LO SIDE LEAKAGE test pushbutton. Use the Safety Leakage Probe to make contact with the metal chassis of the unit under test. If the cold or grounded side of the line is properly wired to the chassis, the PR57 meter will read full scale. No meter deflection indicates that the cord is wired improperly. *NOTE: Do not depress the leakage button on the Safety Leakage Probe for the above test.*

To check the wiring of the ON-OFF switch:

1. Plug the unit to be tested into the ISOLATED OUTPUT on the PR57 and turn both units ON.

2. Depress the HI SIDE leakage test button. Use the Safety Leakage Probe to make contact with the AC line terminals on the on-off switch. If the meter reads full scale deflection, the switch is correctly wired into the hot side of the AC line. No deflection on the meter indicates the switch is wired to the wrong side of the AC power line. *NOTE: Do not depress the leakage button on the Safety Leakage Probe for this test.*

TESTING TRANSFORMER OPERATED DEVICES FOR AC LEAKAGE

The power transformer used in electronic equipment should isolate the chassis of the equipment from the AC power line. There are occasions where the transformer may internally short; primary to the frame or primary to secondary. This results in a hot chassis. Some sets have bypass capacitors from each side of the AC line to the chassis to bypass RF interference. A shorted or leaky bypass capacitor will also result in a hot chassis. Either of these conditions will be located by performing the Safety Leakage Test. The circuit fault is easier to locate by noting which LEAKAGE button is pressed for the high leakage reading. If, for example, the highest leakage read is obtained when the HI SIDE button is pressed, the leakage is following the path for the hot side of the polarized PR57 output jack. The leakage path may be traced through the power cord by simply touching the Safety Leakage Probe to both sides of the AC line cord inside the unit under test with the HI SIDE button (in this example) pressed. The meter will read full-scale when the correct side of the AC line is contacted.

READING AC LEAKAGE LEVELS BELOW 100 MICROAMPS

The PR57 is designed to cover the normal range of AC leakage found in consumer electronics, 100 to 800 microamps. It is often desirable to read leakage currents below 100 microamps. This can be accomplished by using a DVM that will read AC current below 100 μ A, such as the Sencore DVM37 or DVM38. Just follow this procedure:

1. Connect the common lead of the DVM to the PROBE input jack on the PR57.
2. Plug the unit to be tested for leakage into the isolated output on the PR57 and turn both units on.
3. Depress the AC VOLTS OUTPUT pushbutton and adjust the AC VOLTS control for a reading of 117 volts on the PR57 meter.
4. Depress the HI SIDE LEAKAGE pushbutton. Use the DVM meter probe to touch the points that would normally be tested with the Safety Leakage Probe. Read the leakage current on the DVM.
5. Depress the LO SIDE LEAKAGE pushbutton and repeat step 4.

MAINTENANCE

WARNING

These servicing instructions are for use by qualified personnel only. To avoid electric shock, do not perform any servicing other than that contained in the operating instructions unless you are qualified to do so.

DISASSEMBLY INSTRUCTIONS

1. Set the PR57 in its normal operating position. Remove the two screws securing the top to the end cap with the handle. These are the screws directly above the handle.
2. Set the PR57 on the end with the handle. Remove the five screws securing the end cap to the case. Do not remove the two screws securing the end cap to the top as the end cap and top will be removed as one piece.
3. Carefully lift the end cap and top away from the case. This will expose the internal controls and PC board for calibration and service.

To remove the PC board from the PR57:

1. Remove the end cap and top as described above.
2. Unplug the four connectors going to the PC board.
3. Remove the two screws securing the PC board to the case. These must be removed from the bottom of the case.
4. Carefully pull the PC board back and up slightly away from the front panel. Note that there are two mounting pins on the front panel that secure the switches and PC board. Pull the PC board back past these pins to disengage it totally from the case.
5. To replace the PC board, reverse the above procedure being sure that the pins on the front panel are aligned with the holes in the switch bracket before pushing the assembly forward.

PR57 CALIBRATION PROCEDURE

WARNING

The following procedure is intended for use only by a qualified technical person who understands the potential shock hazard that exists with the PR57 cover removed. Do not touch any of the internal terminals or exposed leads from the AC load. Make test equipment connections to the PR57 or the AC load ONLY when the power to the PR57 has been turned OFF. Only use an insulated screwdriver to make the internal adjustments.

Equipment required for calibration:

1. Accurate DVM capable of measuring both AC volts average RMS and 2A AC current average RMS.
2. Resistive AC load capable of drawing 1.0 to 1.5 amps. A 100 watt light bulb can be used as a load.
3. Insulated screwdriver.

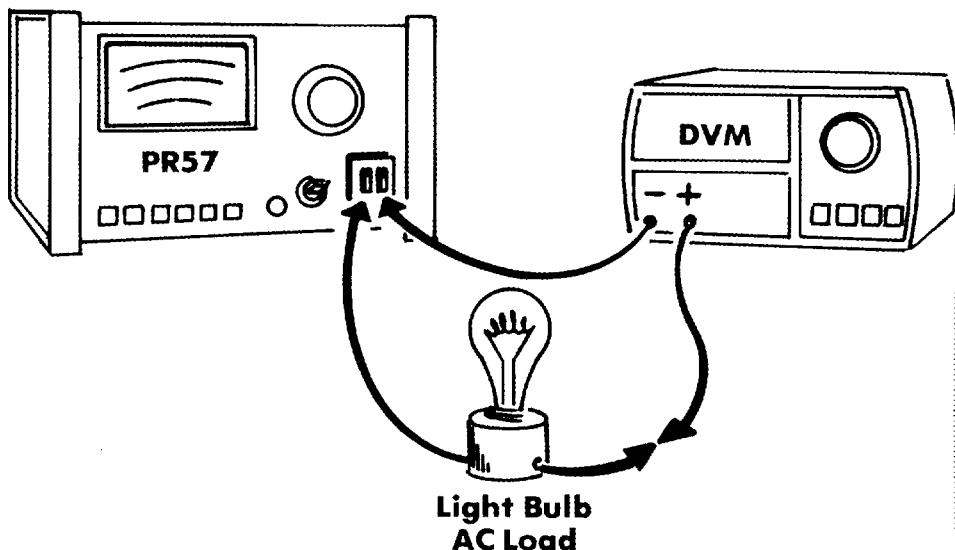

Fig. 6 — AC load and DVM connections for calibration of PR57 1.5 Amp current scale.

The following procedure is used to calibrate the PR57. The controls must be adjusted in the following order to insure proper calibration.

1. Disassemble the PR57 as described in the Disassembly instructions. Do not plug the PR57 into the AC power line at this time.
2. Connect a DVM, set to measure AC current, in series with the AC load. Connect this series combination to the PR57 ISOLATED OUTPUT. Set the AC VOLTS control to minimum or fully counter-clockwise.
3. Depress the 0-1.5A/175W pushbutton, plug the PR57 into the AC power line and turn the ON-OFF/TRIP switch to ON.
4. Adjust the AC VOLTS control while observing the DVM. Set the control for a convenient DVM reading over 1 Amp, such as 1.2 or 1.3 Amps.
5. Adjust the 1.5A CAL control (R12) until the PR57 meter reads the same current as the DVM.

6. Turn the power to the PR57 OFF.

7. Connect the DVM, set to measure AC volts average RMS, to the PR57 ISOLATED OUTPUT. Depress the AC VOLTS OUTPUT pushbutton.

8. Turn the PR57 ON and adjust the AC VOLTS control until the DVM reads 117 volts. Adjust the VOLTAGE CAL control (R6) on the PC board until the PR57 meter reads 117 volts (WATTS OR LEAKAGE SET line on the meter scale). Then disconnect the DVM.

9. Depress the HI SIDE leakage pushbutton. Connect the Safety Leakage Probe to the PROBE jack on the PR57. Insert the probe end into the small prong (right side) of the ISOLATED OUTPUT. The PR57 meter should be 780 microamps. *NOTE: Do not depress the leakage button on the Safety Leakage Probe.*

10. Adjust the LEAKAGE CAL CONTROL (R2) on the PC board for a reading of 780 microamps on the leakage scale of the meter.

This completes the calibration of the PR57. A periodic check can be made of the leakage calibration by simply inserting the Safety Leakage Probe into the ISOLATED OUTPUT and checking for full scale deflection as described in the above calibration procedure.

NOTES

SERVICE & WARRANTY

Warranty

Your PR57 "AC Powerite" has been built to the highest quality standards in the industry. Each unit has been tested, aged under power for at least 24 hours, and then retested on every function and range to insure it met all published specifications after aging. Your instrument is fully protected with a 1 year warranty and Sencore's exclusive 100% Made Right Lifetime Guarantee in the unlikely event a manufacturing defect is missed by these tests. Details are covered in the separate booklet. Read this booklet thoroughly, and keep it in a safe place so you can review it if questions arise later.

Service

The Sencore Factory Service Department provides all in- or out-of-warranty service and complete recalibration services for Sencore instruments. **No local service centers are authorized to repair Sencore instruments.** Factory service assures you of the highest quality work, the latest circuit improvements, and the fastest turnaround time possible because every technician specializes in Sencore instruments. Sencore's Service Department can usually repair your instrument and return it to you faster than a local facility servicing many brands of instruments, even when shipping time is included.

You do not need authorization to return an instrument to Sencore for service. Be sure you include your name and address along with a description of the symptoms if it should ever be necessary to return your instrument. Ship your instrument by United Parcel Service or air freight if possible. Use parcel post only when absolutely necessary.

Be sure the instrument is properly packed. Use the original shipping carton and all packing inserts whenever possible. If the original packing material is not available, make certain the unit is properly packed in a sturdy box with shock-absorbing material on all sides. Sencore suggests insuring the instrument for its full value in case it is lost or damaged in shipment.

A separate schematic and parts list is included if you wish to repair your own instrument. Parts may be ordered directly from the Factory Service Department. Any parts not shown in the parts list may be ordered by description.

We reserve the right to examine defective components before an in-warranty replacement is issued.

SENCORE FACTORY SERVICE

3200 Sencore Drive
Sioux Falls, SD 57107
1-800-SENCORE
FAX: 605/335-6379

Fill in for your records

Date Purchased: _____

Serial Number _____

Run Number _____

(NOTE: Please refer to the run number if it is necessary to call the Service Dept. The run number may be updated when the unit has been returned for service.)

SEN CORE

ELECTRONIC TEST EQUIPMENT

Innovatively Designed With Your Time In Mind

Phone Toll-Free 1-800-SEN CORE

PR57 POWERITE™

Schematic and Parts List

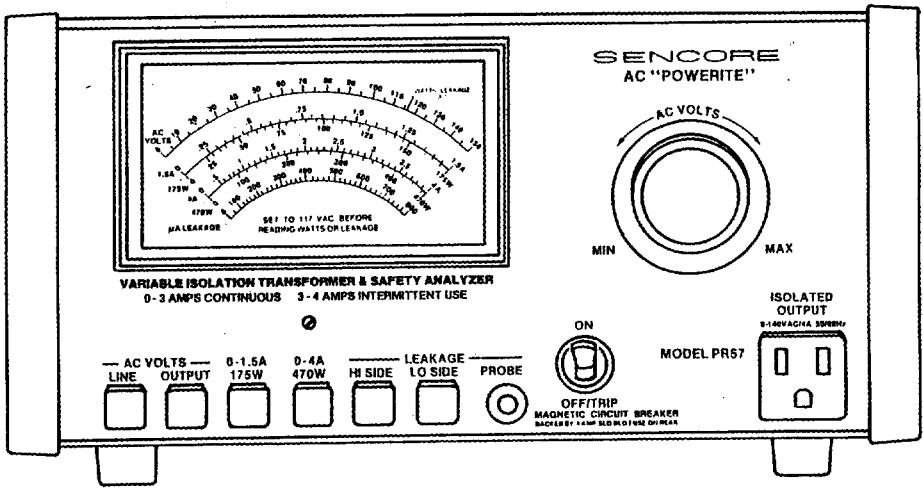

SENCORE 43B165-A

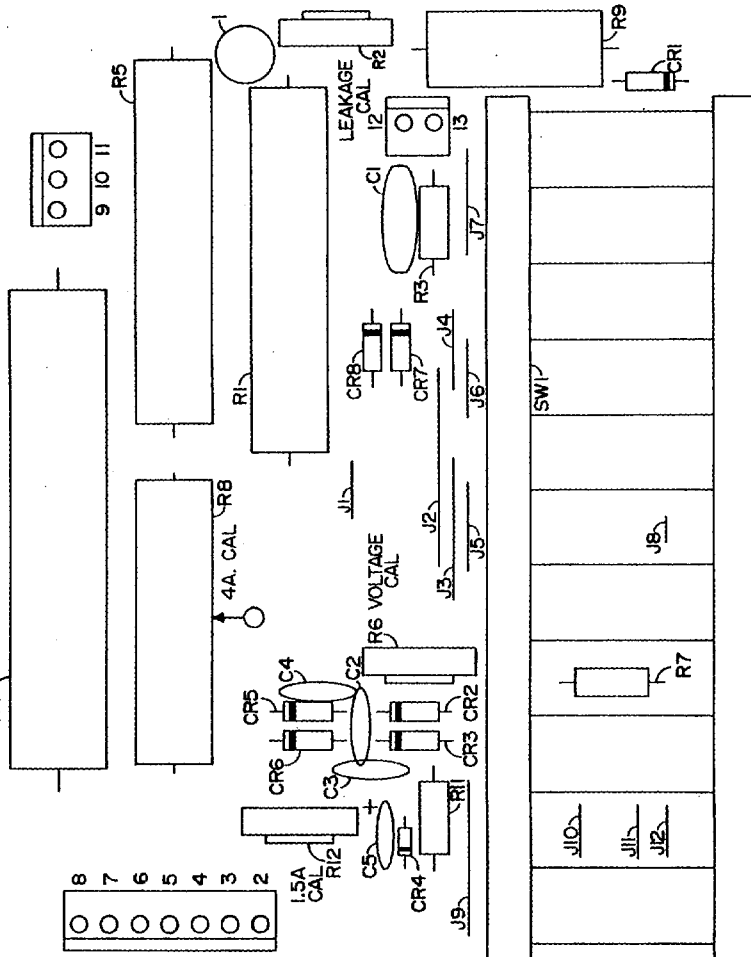

Component Side

PARTS LIST

SCHEMATIC REFERENCE

PART NO.

DESCRIPTION

P.C. BOARD ASSEMBLY 100 BOARD

CR1	16610	Diode, 1N4004 1A 400V PIV
CR2, 3, 5, 6	50C3-2; A	Diode, 1N695
CR4	50C5-2; A	Diode, 1N4148
CR7, 8	50C4-11	Diode, 15V Zener
SW1	25A287; A	Switch, 6 station pushbutton
R1	14A52-18	Resistor, 10K 10W, 10% W.W.
R2	15C7-14	Control, 5K Vert P.C. Linear
R3	14C5-122	Resistor, 1.2K ½W, 10%
R4	14A72-4	Resistor, 1.33 ohm 22W, 5%W.W.
R5	14A52-19	Resistor, .7 ohm 10W, 5% W.W.
R6	15C7-6	Control, 500K Vert P.C. Linear
R7	14C5-125	Resistor, 1.2M ½W, 10%
R8	42E11	Resistance Wire .287 ohm/ft.
R9	14B49-32	Resistor, 8.2K 5W, 10% W.W.
R10	14C5-470	Resistor, 47 ohm ½W, 10%
R11	14C5-103	Resistor, 10K ½W, 10%
R12	15C7-2	Control, 10K Vert P.C. Linear
R13, 14	14B49-10	Resistor, 1K ohm 5W, 10%
C1	24G223	Cap., .15 uF Radial Lead Mylar
C2, 3, 4	24G207	Capacitor, .01 uF dis.
C5	24G382	Capacitor, 10 uF Lytic

EYELET BOARD & CHASSIS

CR201-204	20G18	LED Indicator, Mini
M1	23C70	Meter, 100 uA 1900 ohm 4½"
*T1	28K77	Transformer
*T2	28K78	Transformer, Variable
*SW1	25G284	Switch on/off w/circuit breaker
	8B245	Escutcheon, Front Panel
*F1	44G23	Fuse, 4A Slo Blo
	39G148	Leakage Probe

*Replace only with *exact* manufacturer parts.

Prices in effect at date of printing and are subject to change without notice. When ordering parts, please specify model number, part number, and description. Service and parts invoices are C.O.D. Please include remittance (check or money order) with your order to save C.O.D. charges. Minimum billing \$5.00.

NOTES:

1. See parts list for safety critical parts. Use only exact replacement for continued safety.
2. All resistances are in ohms.
3. All capacitances greater than one are pF, less than one uF, unless otherwise indicated.
4. All controls and jacks on the outside of the unit are shown in a box

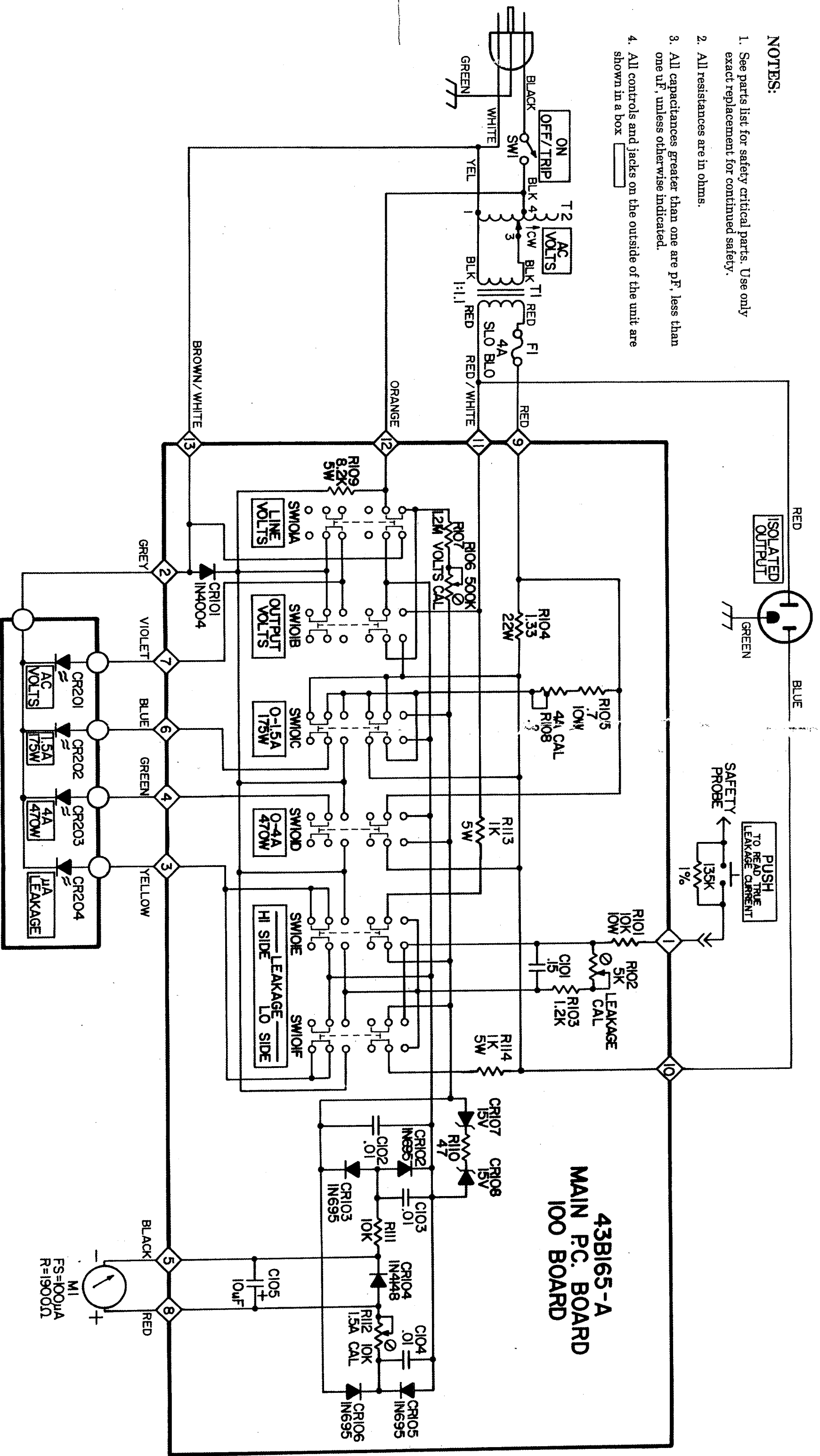

**43B165-A
MAIN P.C. BOARD
100 BOARD**

K4XL's **BAMA**

This manual is provided **FREE OF CHARGE** from the “BoatAnchor Manual Archive” as a service to the Boatanchor community.

It was uploaded by someone who wanted to help you repair and maintain your equipment.

If you paid anyone other than BAMA for this manual, you paid someone who is making a profit from the free labor of others without asking their permission.

You may pass on copies of this manual to anyone who needs it. But do it without charge.

Thousands of files are available without charge from BAMA. Visit us at <http://bama.sbc.edu>